

Brenner Dampf / Burner steam

Spannung / Voltage: **1 N AC 230V 50Hz**

Baugruppe / Group: **5** Ausgabe / Edition: **5.1.1**

Gültig ab Seriennummer / Applicable from serial. no.: **G61CA97101001**

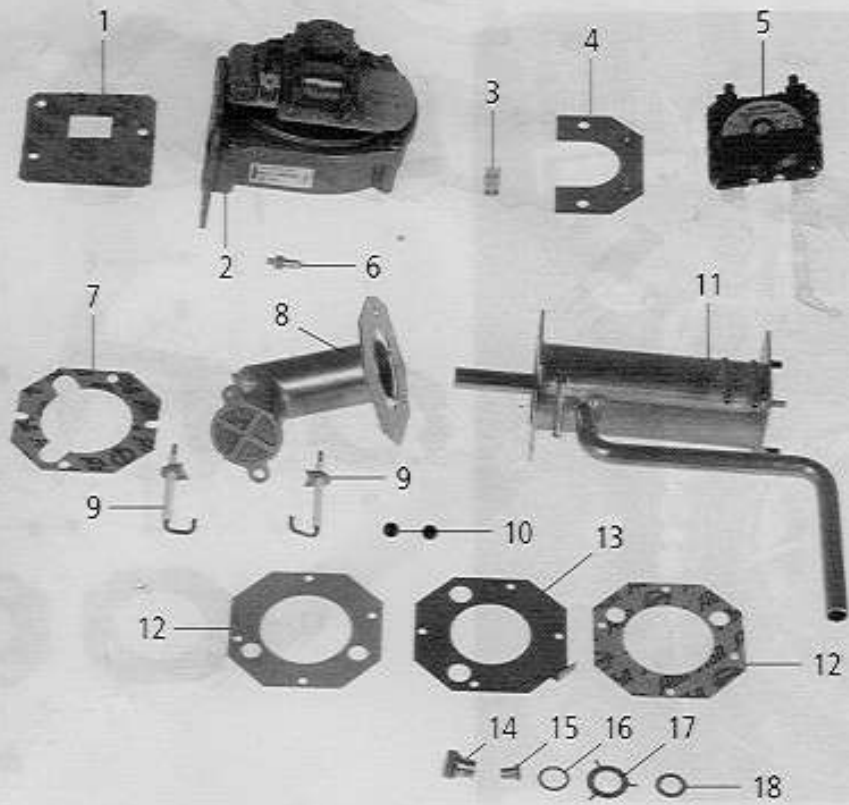
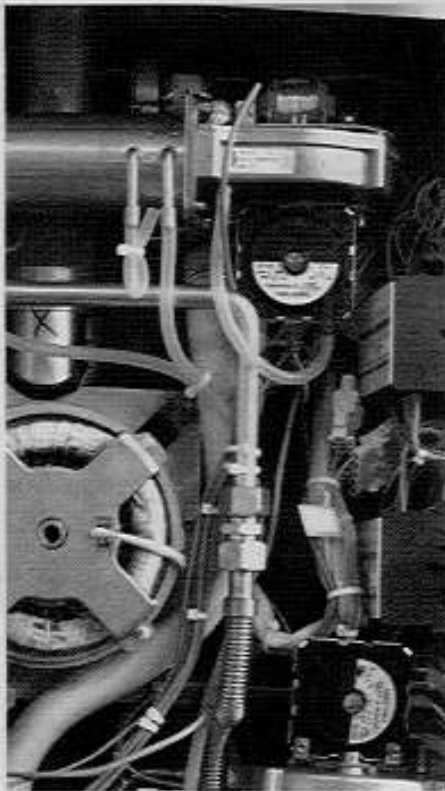

Pos.	St.	Ersatzteil Nr.	Bezeichnung	Description	Bez. Sign.
Pos.	Pcs.	Spare part no.			
1	1		Siehe Ausgabe 5.3.1	See edition 5.3.1	
2	1	3101.1011	Gebläsemotor	Blower motor for gas burner	M3
3	1	3040.0274	Stecker 2-polig	2 pol plug	
4	1	8668.1309	Halterung für Differenzdruckschalter	Fixing bracket for diff. pressure switch	
5	1	3017.1003	Differenzdruckschalter	Differential pressure switch	P3
6	1	3039.0240	Brennerdüse	Burner nozzle	
7	1	5110.1318	Dichtung für Brennergehäuse	Gasket blower connection	
8	1	8668.1315	Brennerrohr	Burner pipe	
9	2	2068.0300	Zünderlektrode	Ignition electrode	B8,8.1
10	2	2022.0111	Kabeldurchführung	Grommet	
11	1	8668.1307	Lüfterrohr Dampf ohne Düse	Blower connection steam without nozzle	
12	2	5110.1318	Dichtung für Brennergehäuse	Gasket blower connection	
13	1		Siehe Ausgabe 5.3.1	See edition 5.3.1	
14	1		Siehe Ausgabe 5.3.1	See edition 5.3.1	
15	1		Siehe Ausgabe 5.3.1	See edition 5.3.1	
16	1	2760.1433	Stützring Vormischscheibe vorne 20x15x1	Front support ring gas disc 20x15x1	
17	1		Siehe Ausgabe 5.3.1	See edition 5.3.1	
18	1	2760.1434	Stützring Vormischscheibe hinten 20x13x1	Back support ring gas disc 20x13x1	

Brenner Heißluft / Burner hot air

 Spannung / Voltage: **1 N AC 230V 50Hz**

 Baugruppe / Group: **5** Ausgabe / Edition: **5.2.1**

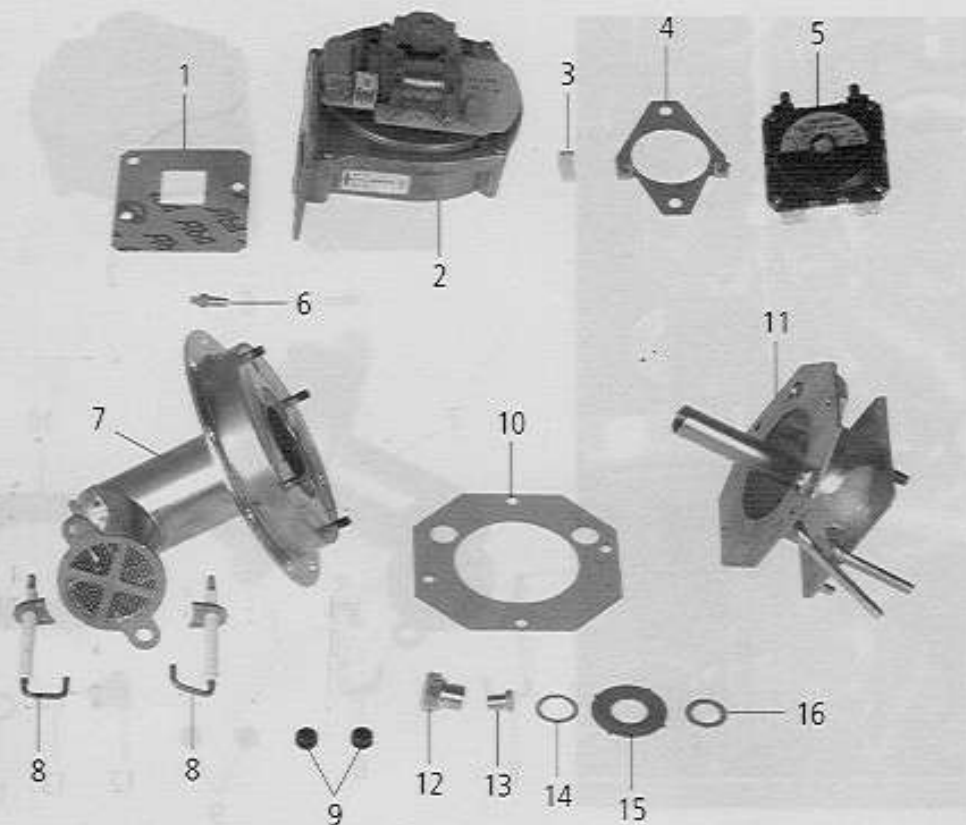
 Gültig ab Seriennummer / Applicable from serial. no.: **G61CA97101001**

Pos.	St.	Ersatzteil Nr.	Bezeichnung	Description	Bez. Sign.
Pos.	Pcs.	Spare part no.			
1	1		Siehe Ausgabe 5.3.1	See edition 5.3.1	
2	1	3101.1011	Gebläsemotor	Blower motor for gas burner	M2
3	1	3040.0274	Stecker 2-polig	2 pol plug	
4	1	2760.1435	Halterung für Differenzdruckschalter	Fixing bracket for diff. pressure switch	
5	1	3017.1003	Differenzdruckschalter	Differential pressure switch	P2
6	1	3039.0240	Brennerdüse	Burner nozzle	
7	1	8668.1313	Heißluft-Brenner Gas	Hot Air burner	
8	2	2068.0300	Zünderlektrode	Ignition electrode	B7,7.1
9	2	2022.0111	Kabeldurchführung	Grommet	
10	1	5110.1318	Dichtung für Brennergehäuse	Gasket blower connection	
11	1	8668.1310	Lüfterrohr Heißluft Gas ohne Düse	Blower connection hot air without nozzle	
12	1		Siehe Ausgabe 5.3.1	See edition 5.3.1	
13	1		Siehe Ausgabe 5.3.1	See edition 5.3.1	
14	1	2760.1433	Stützring Vormischscheibe vorne 20x15x1	Front support ring gas disc 20x15x1	
15	1		Siehe Ausgabe 5.3.1	See edition 5.3.1	
16	1	2760.1434	Stützring Vormischscheibe hinten 20x13x1	Back support ring gas disc 20x13x1	

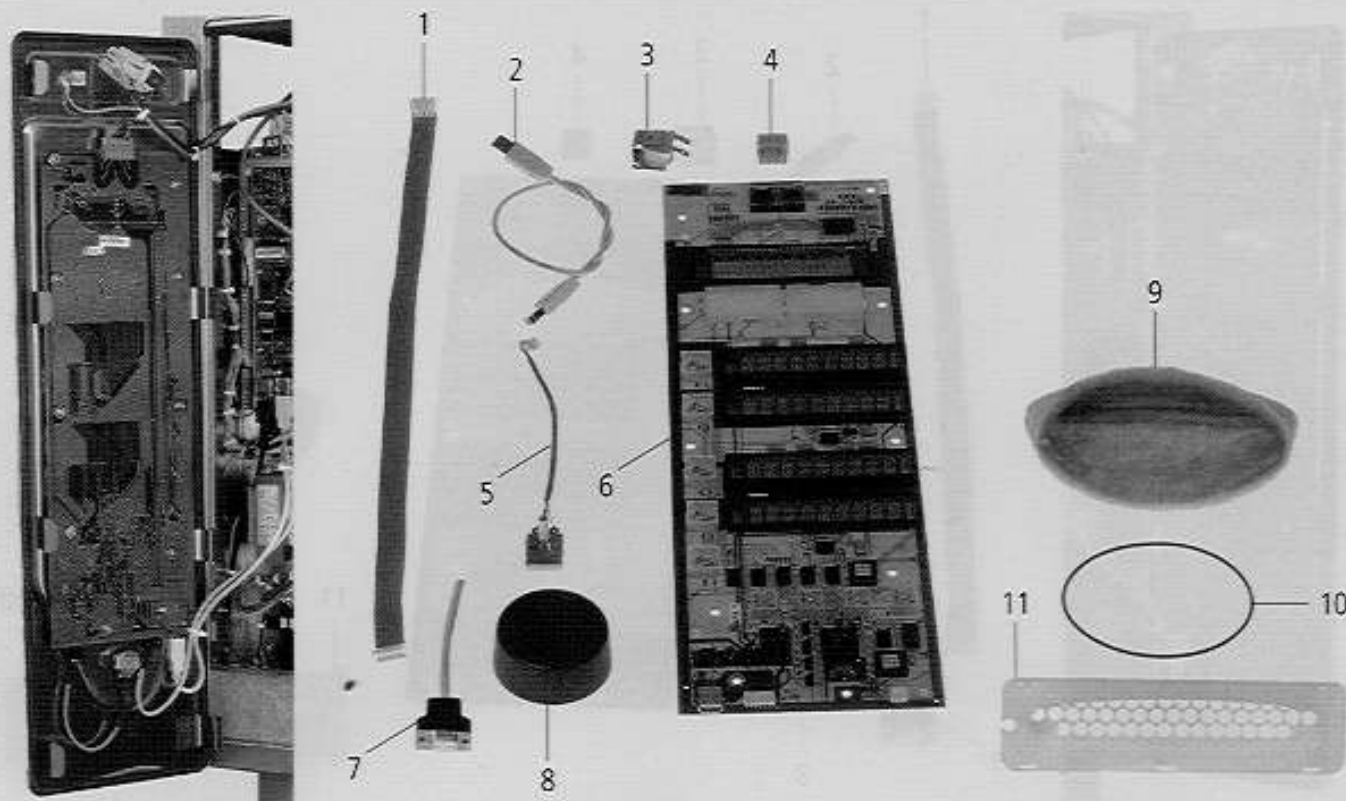
Bedienblende / Control panelSpannung / Voltage: **1 N AC 230V 50Hz**Baugruppe / Group: **1** Ausgabe / Edition: **1.1.1**Gültig ab Seriennummer / Applicable from serial. no.: **G61CA97101001**

Pos.	St.	Ersatzteil Nr.	Bezeichnung	Description	Bez.
Pos.	Pcs.	Spare part no.			Sign.
1	1	8720.1302	Kabel für Spannungsversorgung	Power supply cable operator pcb	
2	1	8720.1300	Datentransferkabel CPU-Bedienplatine	Bus cable CPU - operator pcb	
3	1	3006.0107	Alarmsummer 12V, AC	Buzzer 12V ac	T2
4	1	3040.0255	Steckerleiste 4pol, 5.08	Multipoint connector 4pol, 5.08	
5	1	8817.1303	Impulsgeber kpl.	Pulse generator cpl.	S6
6	1	3040.3020	Bedienplatine	Operator pcb	A1
7	1	8817.1040	Schnittstellenkabel	Interface cable	
8	1	3013.0355	Knebel für Impulsgeber	Dial for pulse generator	
9	1	5214.1300	Luffilter Bedienblende	Air inlet filter control panel	
10	1	5012.0565	O-Ring d 115x2,5mm	O-ring d 115x2,5mm	
11	1	2039.0337	Filterträger Bedienblende	Filter support control panel	
-	1	5100.1011	Dichtung für Blendeneinsatz	Gasket frame for panel	

Gerätetür / Door

Spannung / Voltage: **1 N AC 230V 50Hz**

Baugruppe / Group: **9** Ausgabe / Edition: **9.1.1**

Gültig ab Seriennummer / Applicable from serial. no.: **G61CA97101001**

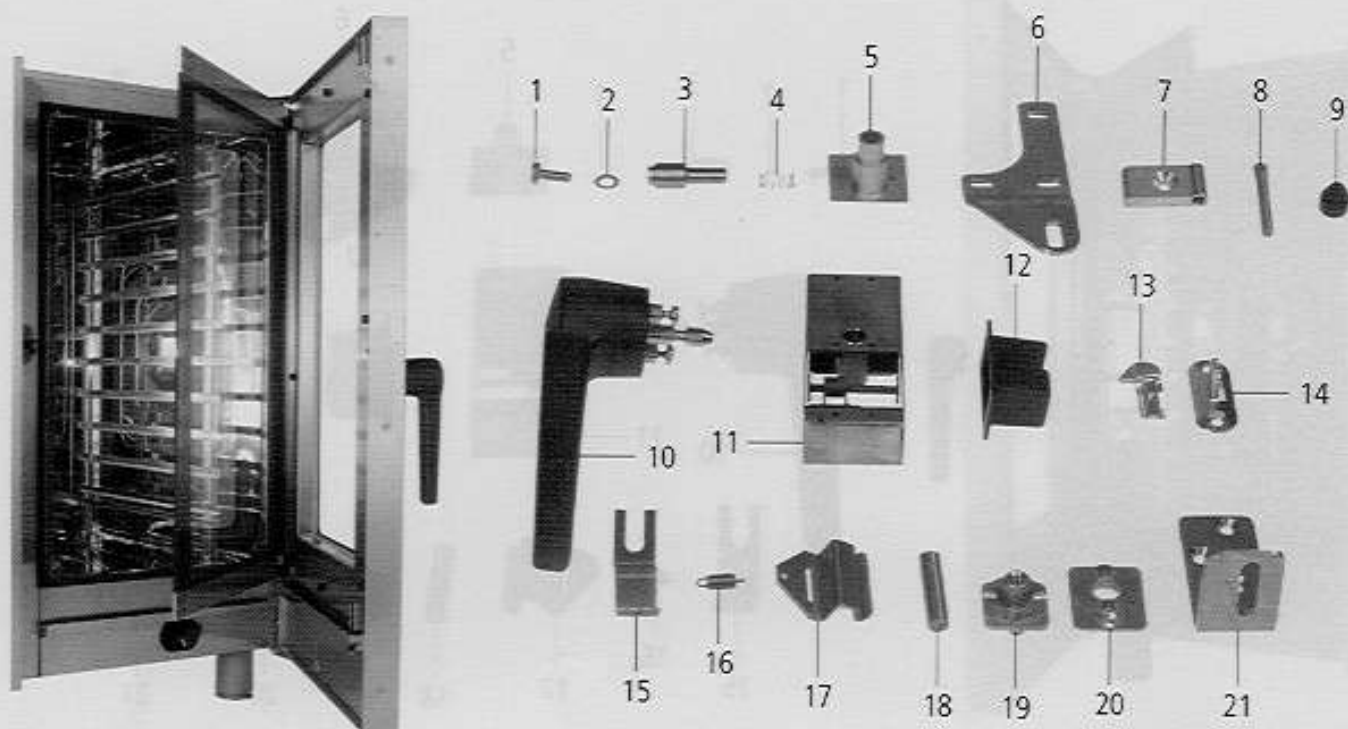

Pos.	St.	Ersatzteil Nr.	Bezeichnung	Description	Bez.
Pos.	Pcs.	Spare part no.			Sign.
-	1	8470.1300	Türe kpl.	Door cpl.	
-	1	8474.1336	Innenglasscheibe kpl.	Internal glass cpl.	
-	1	5105.1020	Garraumdichtung	Door gasket	
1	1	1006.0761	Sechskantschraube M 6x12	Hexagonal screw M 6x12	
2	1	1306.0120	Unterlegscheibe A6,4	Washer A6,4	
3	1	2120.1254	Achszapfen Tür oben	Door bolt top	
4	1	2001.0109	Druckfeder oberer Türhaltebolzen	Compression spring upper door bolt	
5	1	2940.1300	Achshülse Tür oben	Sleeve for door bolt top	
6	1	2930.1307	Türhaltewinkel oben	Door holding angle top	
-	3	1008.0200	Linsenkopfschraube mit Innensechskant	Raised countersunk allen screw M8x16	
7	1	2940.1309	Scharnier für Innenseibe	Hinge for inner glass	
-	2	1005.1960	Senkschraube mit Innensechskant M5x16	Hex socket countersunk head screw M5x16	
8	1	2120.1258	Rändelbolzen für Türhaltescharnier	Knurled bolt for inner door hinge	
9	1	2039.0402	Puffer für Türe	Door buffer	
10	1	2016.1504	Türgriff	Door handle	
11	1	8474.1300	Verschluss kpl. für Tür	Lock for door handle cpl.	
12	1	2039.0319	Abdeckung f. Schloß Innenseite	Internal lock cover	
13	1	2940.1312	Kloben für Türe	Door catch	
-	1	1005.2000	Sperrzahnschraube M 5x8	Interlocking tooth screw M 5x8	
14	1	2940.1313	Klobenhalter für Türe	Base for door catch	
-	2	1006.0761	Sechskantschraube M 6x12	Hexagonal screw M 6x12	
15	1	2760.1396	Federhalter für Arretierung Innenglasscheibe	Spring support	
16	1	2002.0106	Zugfeder für Arretierung Innenglasscheibe	Tension spring for inner window	
17	1	2760.1395	Arretierung Innenglasscheibe	Holding bracket for interior glass	
18	1	3016.1409	Magnet rund Tischgeräte	Magnet round table models	
19	1	2940.1302	Rasthülse	Door setting bolt	
-	1	1008.0766	Sechskantschraube M8x30	Hexagonal screw M8x30	
20	1	2940.1303	Rastzapfen 110°	Stop bolt 110°	
-	1	1005.1960	Senkschraube mit Innensechskant M5x16	Hex socket countersunk head screw M5x16	
21	1	2930.1306	Türhaltewinkel unten	Door mounting support bottom	
-	3	1006.1960	Senkschraube mit Innensechskant M6x16	Hexagonal socket countersunk head screw M6x16	

Elektromontageplatte / Electrical Installation

Spannung / Voltage: **1 N AC 230V 50Hz**

Baugruppe / Group: **2** Ausgabe / Edition: **2.2.1**

Gültig ab Seriennummer / Applicable from serial. no.: **G61CA97101001**

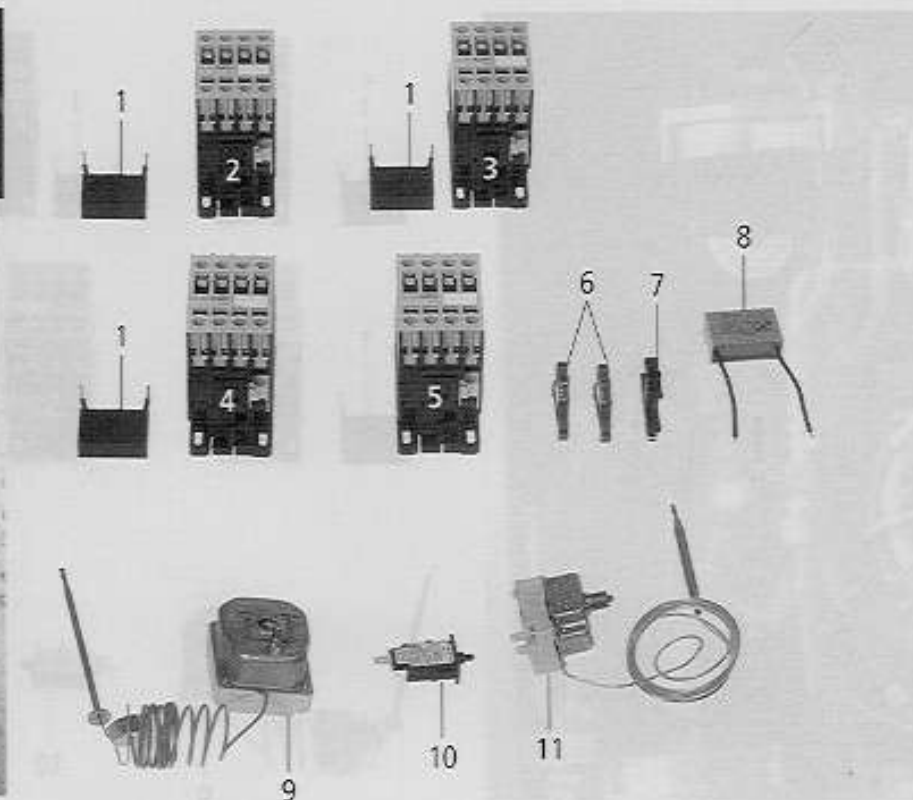
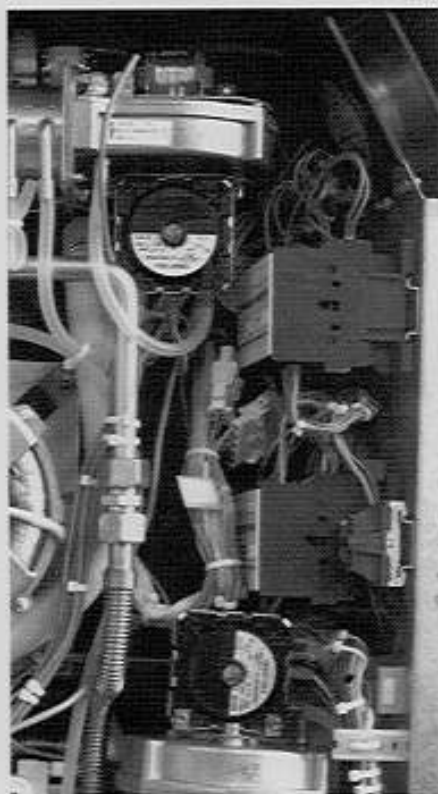

Pos.	St.	Ersatzteil Nr.	Bezeichnung	Description	Bez. Sign.
Pos.	Pcs.	Spare part no.			
1	3	3028.0562	RC-Glied für LS4K - LS30K	RC-link for LS4K - LS30K	C4-C6
2	1	3028.0550	Schütz AEG LSW4K01	Contactora AEG LS4K01	K2
3	1	3028.0550	Schütz AEG LSW4K01	Contactora AEG LS4K01	K3
4	1	3028.0551	Schütz AEG LS4K10	Contactora AEG LS 4K10	K4
5	1	3028.0551	Schütz AEG LS4K10	Contactora AEG LS 4K10	K1
6	2	4001.1216	Reihenklemme 4mm ² grau	Terminal 4mm ² grey	
7	1	4001.1203	Endklammer für Tragschiene	End plate for supporting rail	
8	1	3102.1000	Wechselspannungskondensator 1,5 µF	Capacitor 1,5 µF 250V AC	C3
9	1	3014.0326	Sicherheitstemperaturbegrenzer 360°C	Safety temperature limiter 360°C	F3
10	1	3014.0402	Überstromauslöser 1polig Motorschutz	Motor protector	F4
11	1	3014.0300	Trockengehschutz 135°C	Dry up protector 135°C	F2

Elektromontageplatte / Electrical Installation

Spannung / Voltage: **1 N AC 230V 50Hz**

Baugruppe / Group: **2** Ausgabe / Edition: **2.1.1**

Gültig ab Seriennummer / Applicable from serial. no.: **G61CA97101001**

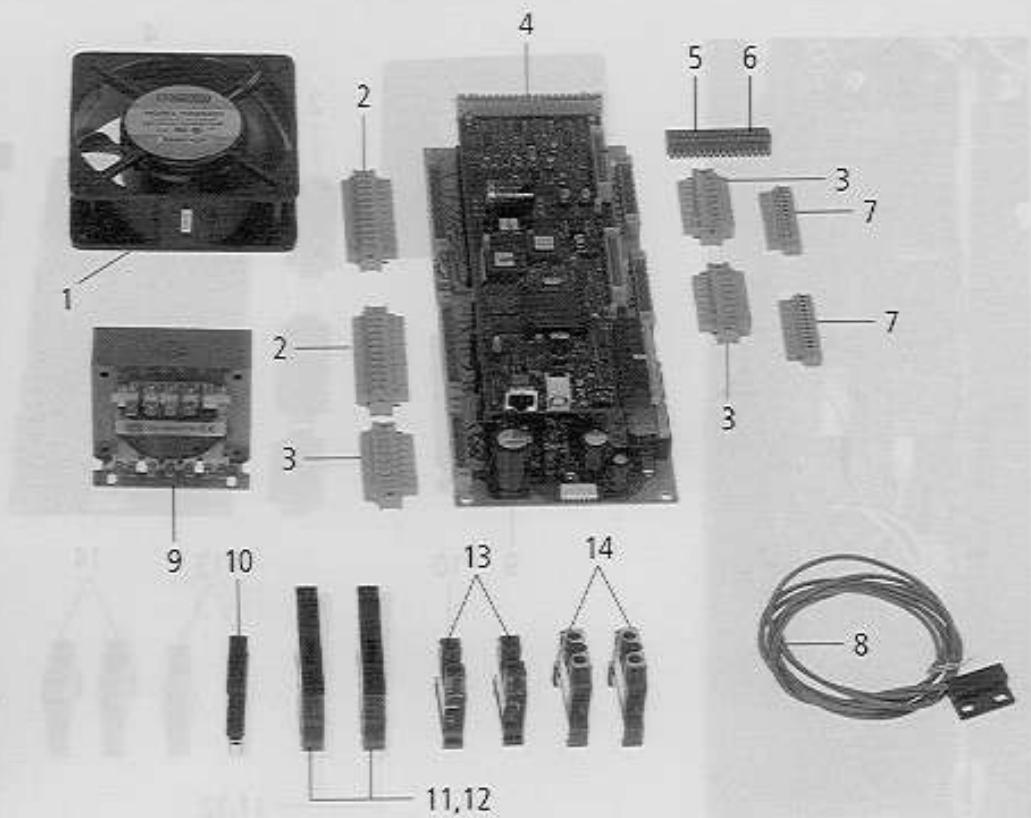
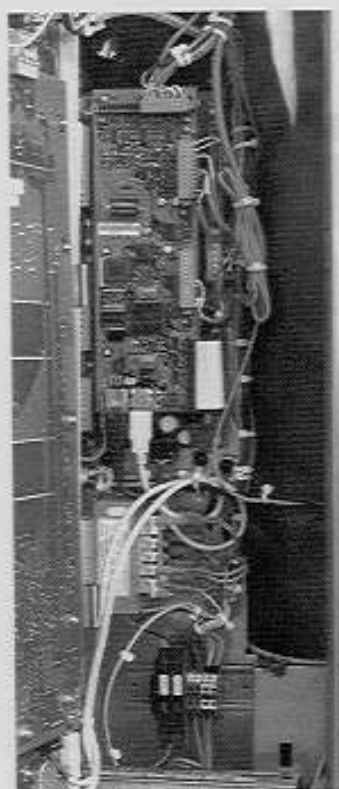

Pos.	St.	Ersatzteil Nr.	Bezeichnung	Description	Bez. Sign.
Pos.	Pcs.	Spare part no.			
1	1	3101.1008	Kühllüfter	Cooling motor	M4
2	2	3040.0254	Steckerleiste 12pol, 5.08	Multipoint connector 12pol, 5.08	
3	3	3040.0253	Steckerleiste 8polig, 5.08	Multipoint connector 8pol, 5.08	
4	1	3040.3000	Steuerelektronik	PCB power supply / cpu	A2,A3
5	1	3040.0262	Steckerleiste links 10polig, 3.5	Multipoint connector left 10polig, 3.5	
6	1	3040.0261	Steckerleiste rechts 10polig 3.5	Multipoint connector right 10polig	
7	2	3040.0256	Steckerleiste 12pol, 3.5	Multipoint connector 12pol, 3.5	
8	1	3016.1415	Türkontaktschalter	Door contact switch	S3
9	1	3037.0240	Steuertrafo 200-260V	Control transformer 200-260V	T1
10	1	4001.1203	Endklammer für Tragschiene	End plate for supporting rail	
11	2	4001.1283	Sicherungsklemme 6x32 4 qmm	Fuse holder terminal block 4qmm 6x32mm	F1,F5
12	2	4001.0224	Sicherung 6.35x32mm, 6.3A träge	Fuse 6.35x32mm, 6.3A slow	F1,F5
13	2	4001.1216	Reihenklammer 4mm² grau	Terminal 4mm² grey	
14	2	4001.1222	Erdungsreihenklammer 4mm² gelb/grün	Earth terminal 4mm² yellow/green	

Gasbauteile / Gas specific parts

Spannung / Voltage: **1 N AC 230V 50Hz**

Baugruppe / Group: **4** Ausgabe / Edition: **4.1.1**

Gültig ab Seriennummer / Applicable from serial. no.: **G61CA97101001**

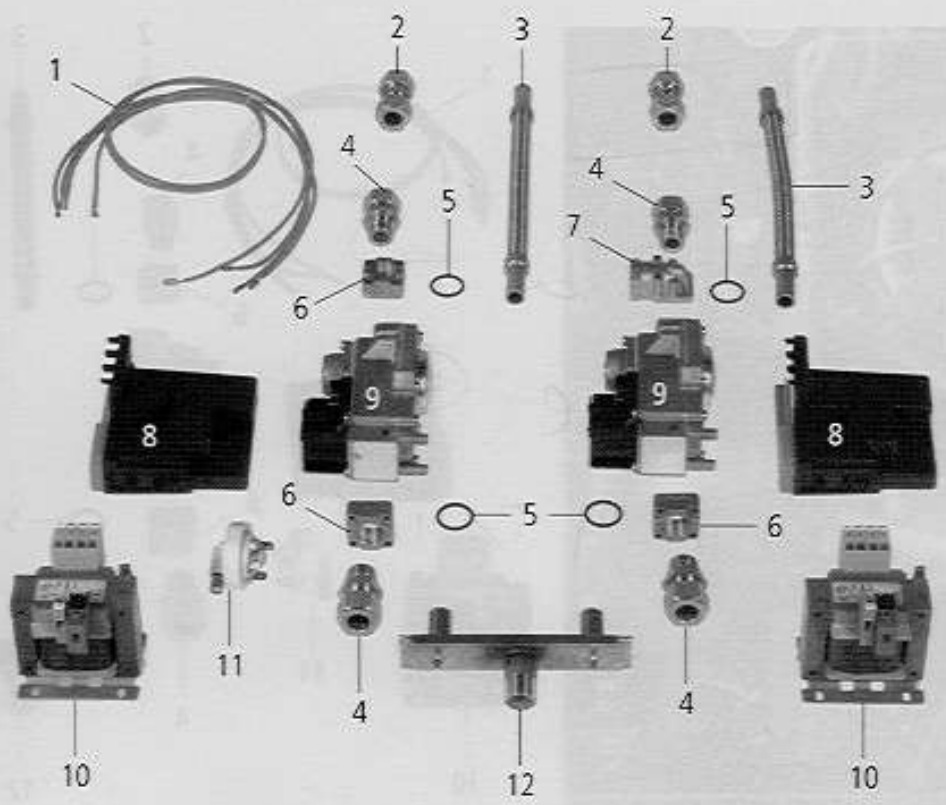
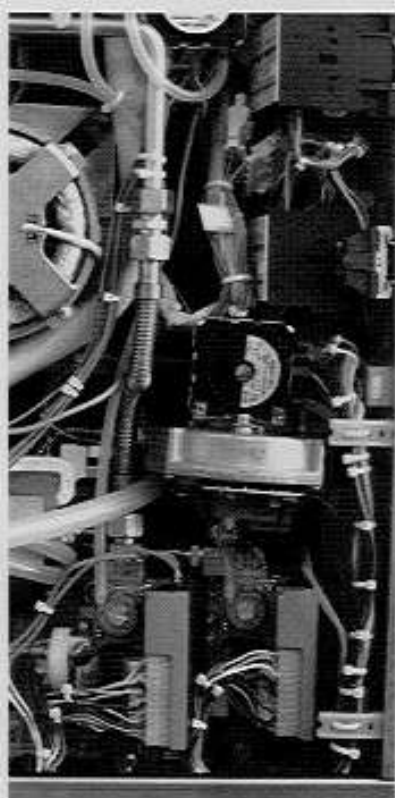

Pos.	St.	Ersatzteil Nr.	Bezeichnung	Description	Bez. Sign.
Pos.	Pcs.	Spare part no.			
1	1	8801.1208	Kabelsatz für Zünd- und Überwachungskabel	Cable set ignition and flame monitoring	
2	2	2036.0606	Ermeto Verschraubung EOG-15PL,A3C	Ermeto threading EOG-15PL,A3C	
3	2	2115.1006	Ringwellschlauch Gasventil	Flexible gas valve connection	
4	4	2036.0600	Ermeto Verschraubung GE-15	Ermeto gas fitting GE-15	
5	4	5012.0572	O-Ring für Anschlußflansch	O-ring for gas connection flange	
6	3	2036.0614	Anschlußflansch 1/2" für Gasventil gerade	Connecting flange 1/2" for gas valve straight	
7	1	2062.0111	Anschlußflansch 1/2" 90°	Gas connection flange 1/2", 90° elbow	
8	2	3039.0105	Gasfeuerungsautomat	Gas ignition module	A4,5
9	2	3039.0241	Gasventil Dampf/ Heißluft	Gas valve steam/ hot air	Y4,5
10	2	3037.0242	Trafo Gebläsemotor 230/24V	Transformer blower motor 230/24V	T3,4
11	1	3017.1004	Gasdruckwächter	Gas pressure switch	F7
12	1	2019.1326	Gasverteiler Hauptanschluß	Gas valve connection manifold	

Gastypen, Einstellwerte / Gas types, adjustment values

 Spannung / Voltage: **1 N AC 230V 50Hz**

 Baugruppe / Group: **5** Ausgabe / Edition: **5.3.1**

 Gültig ab Seriennummer / Applicable from serial. no.: **G61CA97101001**

Gas / Gas	Gas / Gas	Gas / Gas	Gas / Gas	Gas / Gas
Flüssiggas 3B/P LPG 3B/P	Flüssiggas 3P LPG 3P	Flüssiggas 3+ LPG 3+	Erdgas H Natural gas H	Erdgas L Natural gas L
Referenz 5.1.1 Brenner Dampf / Reference 5.1.1 Burner steam				
	$n = 99,2 \text{ s}^{-1}$ $P_{\Delta} = 5,1 \text{ mbar}$ $P_{\text{Pe}} = P_{\text{AN}}$	$n = 96,6 \text{ s}^{-1}$ $P_{\Delta} = 5,4 \text{ mbar}$ $P_{\text{Pe}} = 25,1 \text{ mbar}$	$n = 84 \text{ s}^{-1}$ $P_{\Delta} = \text{mbar}$ $P_{\text{Pe}} = 23,5 \text{ mbar}$	$n = 89 \text{ s}^{-1}$ $P_{\Delta} = \text{mbar}$ $P_{\text{Pe}} = 8,3 \text{ mbar}$
	2120.1274 $\varnothing 1,8 \text{ mm}$	2120.1274 $\varnothing 1,8 \text{ mm}$	2120.1274 $\varnothing 1,8 \text{ mm}$	2120.1272 $\varnothing 2,4 \text{ mm}$
	2120.1288 $\varnothing 1,75 \text{ mm}$	2120.1289 $\varnothing 1,95 \text{ mm}$	2120.1293 $\varnothing 2,15 \text{ mm}$	2120.1278 $\varnothing 3,4 \text{ mm}$
	2760.1427 $\varnothing 26,5 \text{ mm}$	2760.1427 $\varnothing 26,5 \text{ mm}$	2760.1427 $\varnothing 26,5 \text{ mm}$	2760.1484 $\varnothing 24 \text{ mm}$
	2770.1444 $\varnothing 51 \text{ mm}$	2770.1444 $\varnothing 51 \text{ mm}$	2770.1307 $\varnothing 53 \text{ mm}$	2770.1307 $\varnothing 53 \text{ mm}$
	5110.1313 b 13 mm	5110.1313 b 13 mm	5110.1320 b 15 mm	5110.1320 b 15 mm
Referenz 5.2.1 Brenner Heißluft / Reference 5.2.1 Burner hot air				
	$n = 102,5 \text{ s}^{-1}$ $P_{\Delta} = 1,4 \text{ mbar}$ $P_{\text{Pe}} = P_{\text{AN}}$	$n = 102,5 \text{ s}^{-1}$ $P_{\Delta} = 1,4 \text{ mbar}$ $P_{\text{Pe}} = 20,3 \text{ mbar}$	$n = 102,5 \text{ s}^{-1}$ $P_{\Delta} = \text{mbar}$ $P_{\text{Pe}} = 25,8 \text{ mbar}$	$n = 102,5 \text{ s}^{-1}$ $P_{\Delta} = \text{mbar}$ $P_{\text{Pe}} = 8,5 \text{ mbar}$
	2120.1274 $\varnothing 1,8 \text{ mm}$	2120.1274 $\varnothing 1,8 \text{ mm}$	2120.1274 $\varnothing 1,8 \text{ mm}$	2120.1273 $\varnothing 2,2 \text{ mm}$
	2120.1282 $\varnothing 2 \text{ mm}$	2120.1283 $\varnothing 2,2 \text{ mm}$	2120.1283 $\varnothing 2,2 \text{ mm}$	2120.1280 $\varnothing 4,4 \text{ mm}$
	2760.1494 $\varnothing 33 \text{ mm}$	2760.1494 $\varnothing 33 \text{ mm}$	2760.1494 $\varnothing 33 \text{ mm}$	2760.1485 $\varnothing 34 \text{ mm}$
	5110.1319 b 18 mm	5110.1319 b 18 mm	5110.1319 b 18 mm	5110.1319 b 18 mm

Handbrause / Hand shower

Spannung / Voltage: **1 N AC 230V 50Hz**

Baugruppe / Group: **11** Ausgabe / Edition: **11.1.1**

Gültig ab Seriennummer / Applicable from serial. no.: **G61CA97101001**

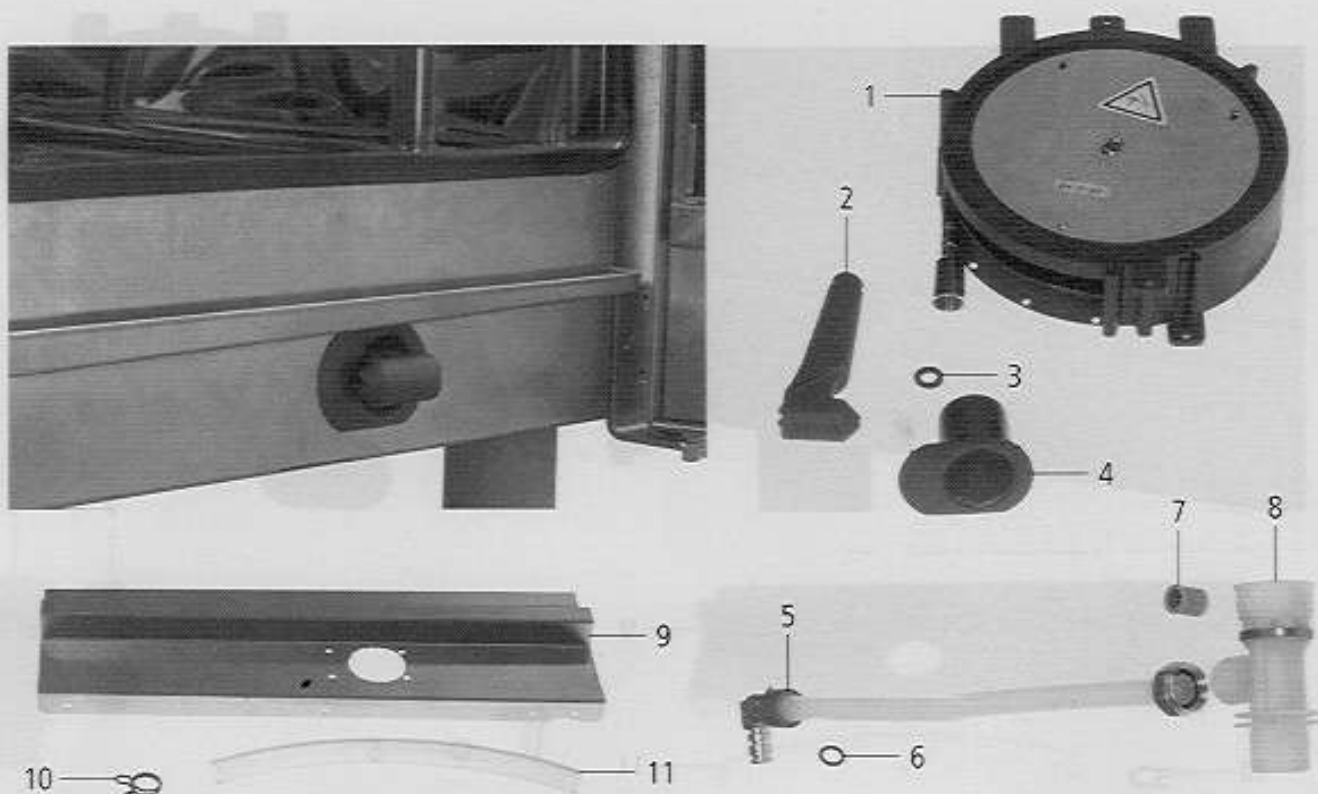

Pos.	St.	Ersatzteil Nr.	Bezeichnung	Description	Bez.
Pos.	Pcs.	Spare part no.			Sign.
1	1	8655.2021	Schlauchroller	Handshower roll guide	
2	1	2060.1000	Handbrause	Hand shower	
3	1	5012.0539	Dichtung für Verschraubung G 1/2"	Gasket for G1/2" threaded joint	
4	1	2060.1210	Tulpe für Handbrause	Tulip for handshower	
-	4	1107.0103	Schnellbefestiger d3mm	Quick fastener d3mm	
5	1	2062.0327	Anschlußrohr Schlauchroller	Connecting pipe hand shower	
6	2	2060.0228	O-Ring für Brauseschlauch	O-ring for shower hose	
7	1	2069.0105	Rückschlagventil DN8	Non return valve DN8	
8	1	8664.1300	T-Stück Wasseranschluss Handbrause	T-water connection handshower	
9	1	8455.1315	Gerätetropfwanne	Drip collector	
10	2	2066.0525	Schlauchklemme 22,1mm	Hose clamp 22,1mm	
11	1	2110.1002	Silikonschlauch d15x3	Silicone hose d15x3	

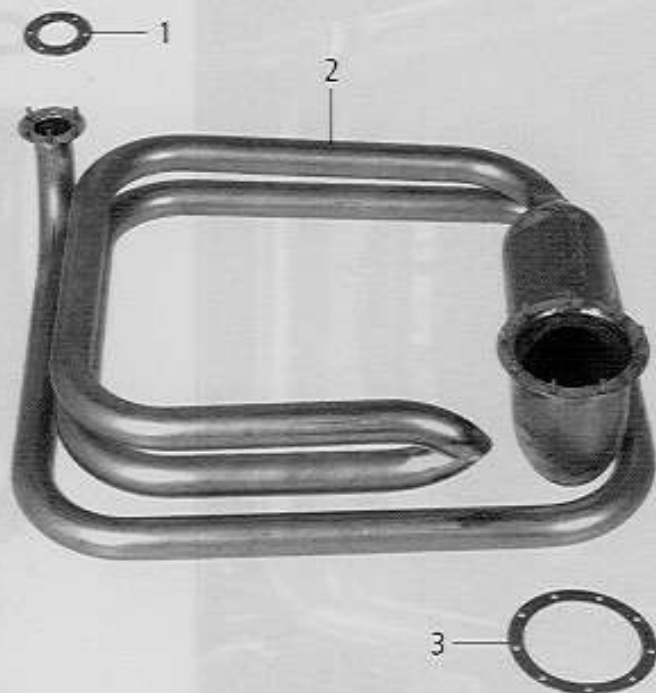
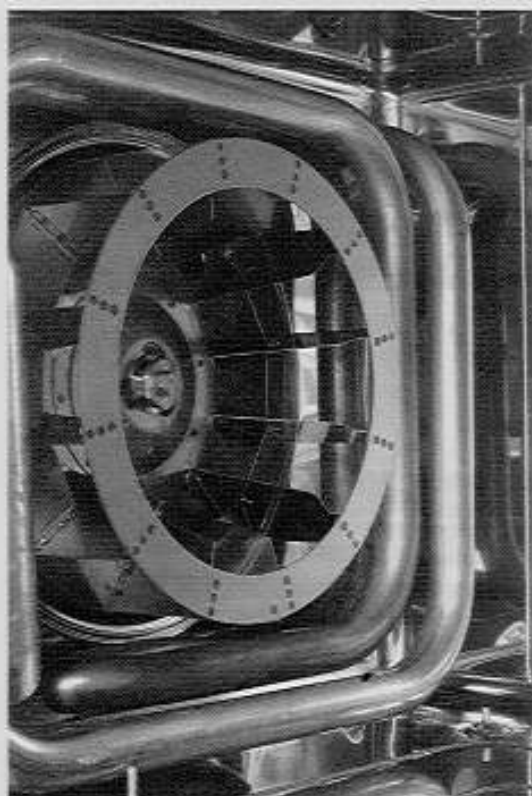
Wärmetauscher Heißluft / Heat exchanger hot airSpannung / Voltage: **1 N AC 230V 50Hz**Baugruppe / Group: **6** Ausgabe / Edition: **6.2.1**Gültig ab Seriennummer / Applicable from serial. no.: **G61CA97101001**

Pos.	St.	Ersatzteil Nr.	Bezeichnung	Description	Bez. Sign.
Pos.	Pcs.	Spare part no.			
1	2	5110.1309	Dichtung für Abgasflansch	Gasket flange fue connection	
2	1	8668.1300	Heißluftwärmetauscher	Hot air heat exchanger	
3	2	5110.1311	Dichtung für Brennerflansch	Gasket flange for burner	
4	15	1105.0122	Sechskant-Combi-Mutter M 5	Hexagonal combination nut M5	

Wärmetauscher Dampf / Heat exchanger steam

Spannung / Voltage: **1 N AC 230V 50Hz**

Baugruppe / Group: **6** Ausgabe / Edition: **6.1.1**

Gültig ab Seriennummer / Applicable from serial. no.: **G61CA97101001**

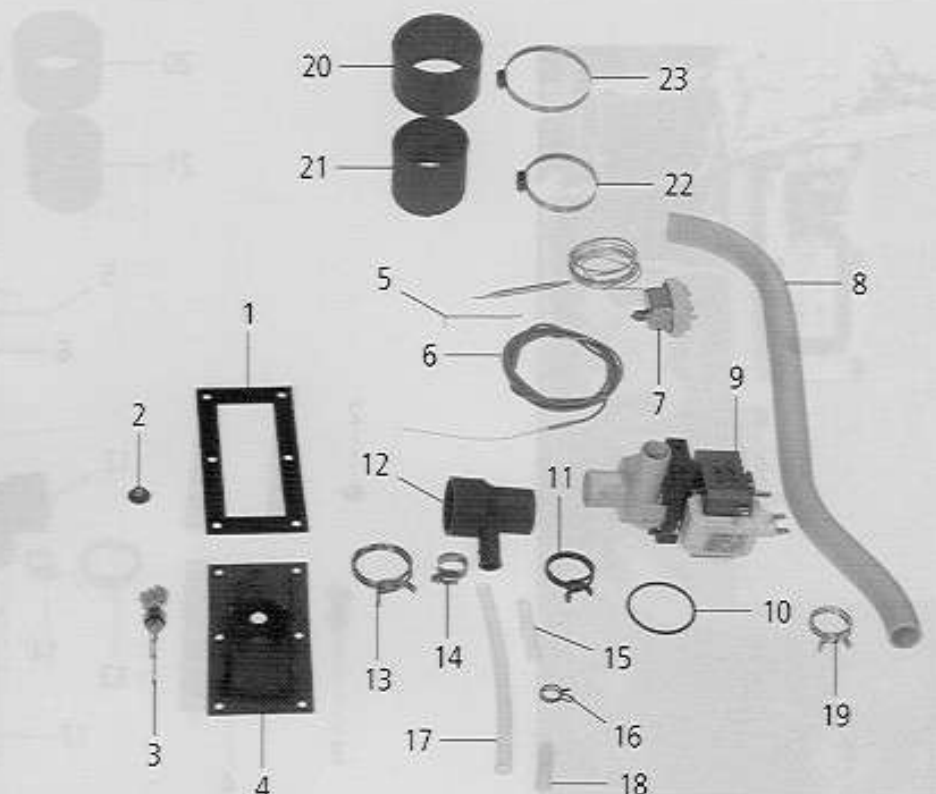
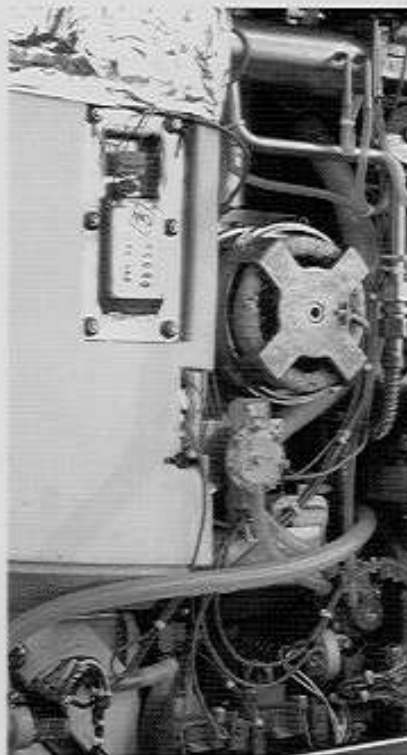

Pos.	St.	Ersatzteil Nr.	Bezeichnung	Description	Bez. Sign.
Pos.	Pcs.	Spare part no.			
-	-	2067.0050	Silikonschlauch 1m	Silicone hose 1m	
-	-	8350.3100	Dampfgenerator	Steam generator	
1	1	5110.1308	Dichtung für Einsatz Niveauelektrode	Gasket for level elektrode insert	
2	6	1105.0122	Sechskant-Combi-Mutter M 5	Hexagonal combination nut M5	
3	1	3002.0409	Füllstandselektrode 74mm	Filling level elektrode 74mm	S2
4	1	8354.1302	Einsatz Niveauelektrode	Level elektrode insert	
5	1	2740.1040	Klemmblech Dampfgenerator	Clamping plate for steam generator	
6	1	3014.0165	Thermoelement Dampfgenerator	Thermo element steam generator	B5
7	1	3014.0300	Trockengehschutz 135°C	Dry up protector 135°C	F2
8	1	2112.1302	Entleerschlauch	Emptying hose	
9	1	3002.1000	Entleerungspumpe 200-240V 50/60Hz	Emptying pump 200-240V 50/60Hz	M6
10	1	5012.0560	O-Ring Dichtung Entleerungspumpe	O-Ring gasket emptying pump	
11	1	2066.0519	Schlauchklemme 35,6mm	Hose clamp 35,6mm	
12	1	2118.1000	Pumpenanschlußstutzen	Pump connection spout	
13	1	2066.0526	Schlauchklemme 46mm	Hose clamp 46mm	
14	1	2066.0530	Schlauchklemme 16,4mm	Hose clamp 16,4mm	
15	1	2062.0331	Verbindungsstück GS 10	Connecting piece GS 10	
16	1	2066.0527	Schlauchklemme 14mm	Hose clamp 14mm	
17	1	2110.1008	Silikonschlauch DG-Entleerung	Drain hose steam generator	
18	1	2120.1259	Stopfen 10mm Entleerschlauch DG	Stop plug 10mm drain hose steam generat.	
19	2	2066.0518	Schlauchklemme 30mm	Hose clamp 30mm	
20	1	2112.1306	Dampfschlauch 50x5mm	Steam hose 50x5mm	
21	1	2112.1006	Dampfschlauch 50x7mm	Steam hose 50x7mm	
22	2	2066.0504	Schlauchschele 40-60mm	Hose clamp 40-60mm	
23	2	2066.0300	Schlauchschele 50-70mm	Hose clamp 50-70mm	

Garraum / Interior cabinet

Spannung / Voltage: **1 N AC 230V 50Hz**

Baugruppe / Group: **8** Ausgabe / Edition: **8.1.1**

Gültig ab Seriennummer / Applicable from serial. no.: **G61CA97101001**

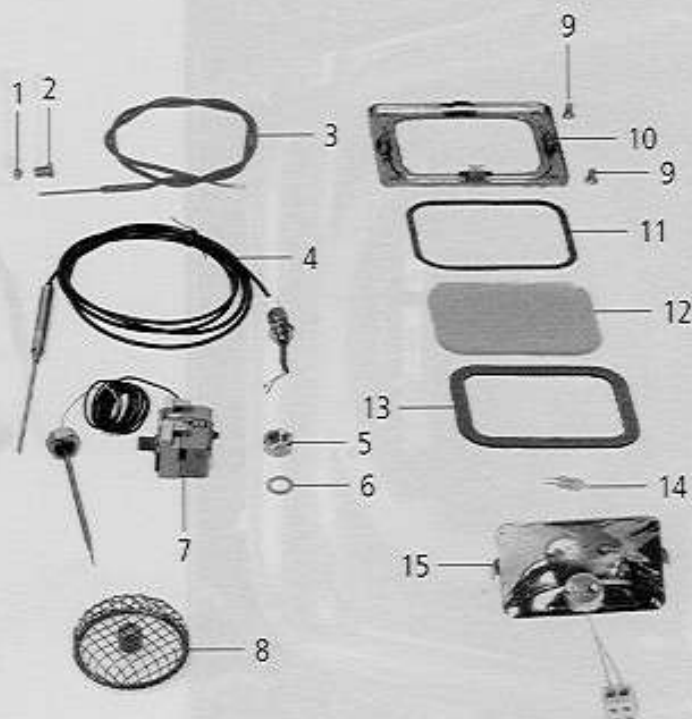
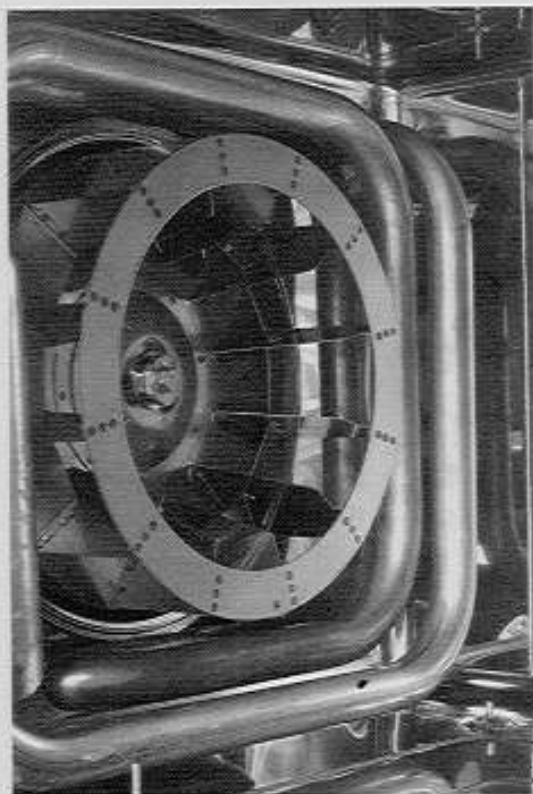

Pos.	St.	Ersatzteil Nr.	Bezeichnung	Description	Bez. Sign.
Pos.	Pcs.	Spare part no.			
-	1	8516.1300	Luftleitblech	Air baffle	
1	1	3014.0162	Dichtkegel für Thermoelement	Sealing cone for thermo element	
2	1	3014.0163	Stopfbuchsnippel für Thermoelement	Gasket sleeve with nipple	
3	1	3014.1000	Thermoelement - lang -	Thermocouple -long-	B1
4	1	3035.0710	Einstechfühler	Meat probe sensor	B3
5	1	1112.0110	Sechskantmutter M 10	Hexagonal nut M10	
6	1	1315.0105	Kupferdichtring für Einstechfühler	Copper washer for meat probe sensor	
7	1	3014.0326	Sicherheitstemperaturbegrenzer 360°C	Safety temperature limiter 360°C	F3
8	1	2005.0302	Ablaufsieb	Outlet sieve	
9	4	1008.0753	Sechskantschraube M 5x8	Hexagonal screw M5x8	
10	1	8514.1017	Andrückrahmen f. Garraumbeleuchtung	Press down frame for interior lighting	
11	1	5110.1022	Dichtungsrahmen außen	External gasket frame	
12	1	5201.1000	Glas f. Garraumbeleuchtung	Glass for interior lamp	
13	1	5110.1023	Dichtungsrahmen innen	Internal gasket frame	
14	1	3024.0201	Halogengarraumlampe 10 W/12V/300°	Halogen bulb 10 W/12V/300°	
15	1	8514.1018	Reflektor kpl. f. Garraumbeleuchtung	Reflector unit for interior lighting	

Sonstiges / Miscellaneous

Baugruppe / Group: 12 Ausgabe / Edition: 12.1.1

Gültig ab Seriennummer / Applicable from serial. no.: G61CA97101001

Pos.	Ersatzteilnr.:	Bezeichnung	Description
Pos.	Spare part no.		
1	1003.2260	Linsensenk-Blechschaube HC4,2x16	Raised countersunk head - self-tapping screw HC4,2x16
2	1004.2160	Sechskant Blechschaube B4,2x16	Hex head tapping screw B4, 2x16
3	1104.0821	Blechmutter B3,9	Climp B3,9
4	1107.0100	Schnellbefestiger d4,0 mm	Quick fastener d4.0 mm
5	1107.0101	Schnellbefestiger d5,0mm	Quick fastener d5,0mm
6	1107.0102	Schnellbefestiger d12mm	Quick fastener d12mm
7	1107.0103	Schnellbefestiger d3mm	Quick fastener d3mm
8	1311.2260	Schraubenrosette 5x12,5	Rosette 5x12,5
9	1603.0165	Blindniete 3,2x9,5	Blind rivet 3.2x9.5
10	1901.0042	Blechklammer für Außenmantel	Clamp for exterior cabinet
11	1901.0044	Blechklammer für Deckel bis 05/95	Clamp for cover up to 05/95
12	2001.0042	Loctite Schraubensicherung 10ml	Screw locking, heat resistant 10ml
13	2005.0603	Lenkrolle d/125 mit Feststeller	Castor d/125 with stopper
14	2005.0604	Lenkrolle d/125 ohne Feststeller	Castor d/125 without stopper
15	2039.0111	Metall-Einsteckfuß 40x40	Foot adjustable metal, 40 x 40
16	2039.0120	Fußoberteil 85mm	Upper part of pedestal 85mm
17	2039.0121	Fußunterteil	Lower part of pedestal
18	3016.1409	Magnet rund Tischgeräte	Magnet round table models
19	4002.0100	Flachsteckhülse 2,5x6,3	Cable shoes 2,5x6,3
20	4004.0100	Aderendhülse 1,0mm ²	Wire end sleeve 1,0mm ²
21	4004.0101	Aderendhülse 1,5mm ²	Wire end sleeve 1,5mm ²
22	4004.0102	Aderendhülse 2,5mm ²	Wire end sleeve 2,5mm ²
23	4004.0103	Aderendhülse 4mm ²	Wire end sleeve 4mm ²
24	4004.0104	Aderendhülse 6mm ²	Wire end sleeve 6mm ²
25	4004.0105	Aderendhülse 10mm ²	Wire end sleeve 10mm ²
26	4004.0106	Aderendhülse 16mm ²	Wire end sleeve 16mm ²
27	4004.0114	Aderendhülse 0,75mm ²	Wire end sleeve 0,75mm ²
28	4005.0101	Kabelbinder 145mm lang	Cable strap 145mm long
29	4005.0102	Kabelbinder 100mm lang	Cable strap 100mm long
30	4007.0305	Kabelverschraubung PG 21	Screw-type conduit fitting PG 21
31	4007.0306	Reduzierstück PG 29/21	Reducing socket PG 29/21
32	4007.0405	Kabelverschraubung PG 16	Screw-type conduit fitting PG 16
33	4007.0406	Reduzierstück PG 29/16	Reducing socket PG 29/16
34	4007.0521	Sechskantmutter für PG 13,5	Hex screw for PG 13,5
35	4007.0526	Sechskantmutter für PG 21	Hex screw for PG 21
36	4007.0604	Kabelverschraubung PG 42 mit Zugentlast.	Cable connection PG 42, strain relief
37	4007.0605	Sechskantmutter PG42	Lock nut cable connection PG 42
38	4007.0606	Kabelverschraubung PG 36	Screw-type conduit fitting PG 36
39	4007.0607	Sechskantmutter für PG 36	Hex screw for PG 36
40	4007.0614	Stopfen PG 13,5	Plug PG 13,5
51	4007.0615	Stopfen PG 21	Plug PG 21
52	4007.0621	Durchführungsstülpe d 36mm	Lead-in grommet d 36 mm
53	5003.0300	Isolierung Dampfgenerator 1250x1250mm	Insulation steam generator 1250x1250mm
54	5006.0200	Tube Silikon E41	Silicone (tube) E41
55	5006.0500	Kleber Isolierung Dampfgenerator 310ml	Adhesive insulation steam generator 310ml
56	6004.0100	Handdruck Sprühpistole	Spray-pistol
57	6004.0101	Verlängerung Handdruck Sprühpistole	Lengthening piece for spray-pistol
58	6004.0102	Dichtung Handdruck Sprühpistole	Gasket for spray-pistol
59	6004.0203	Entkalker-Fußpumpe	Descaler foot pump
60	6006.0101	RATIONAL Spezialreiniger	RATIONAL special cleaning agent
61	6006.0110	RATIONAL Entkalker	RATIONAL descaler
62	9003.0202	Unimoly plus, 180 °C	Unimoly plus, 180 °C
63	9006.0850	Metallwaschcreme	Stainless steel cleaning paste

Motor und Lüfterrad / Motor and fan wheel

Spannung / Voltage: **1 N AC 230V 50Hz**

Baugruppe / Group: **7** Ausgabe / Edition: **7.1.1**

Gültig ab Seriennummer / Applicable from serial. no.: **G61CA97101001**

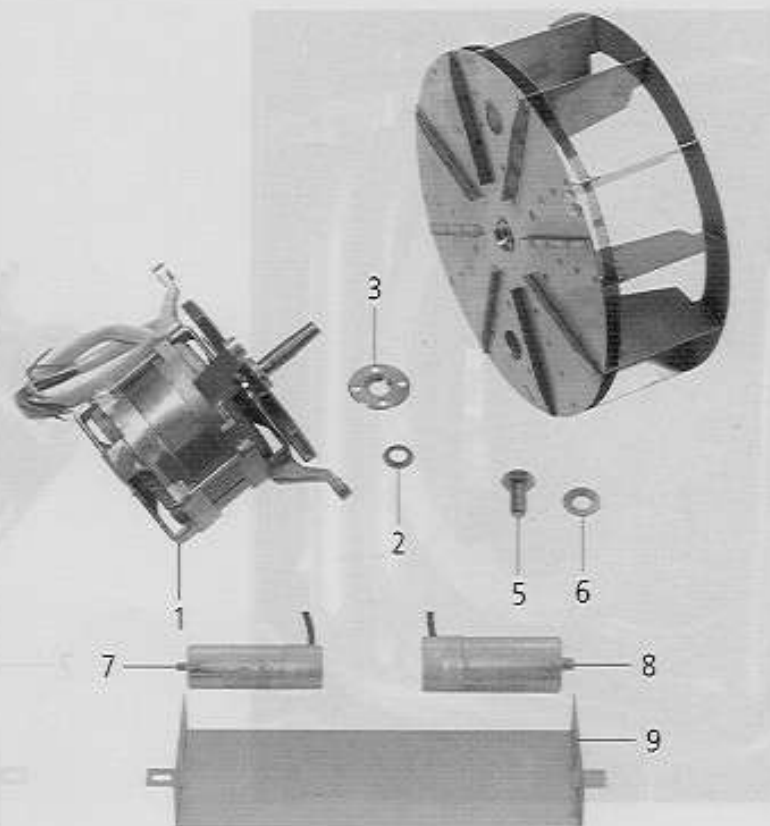
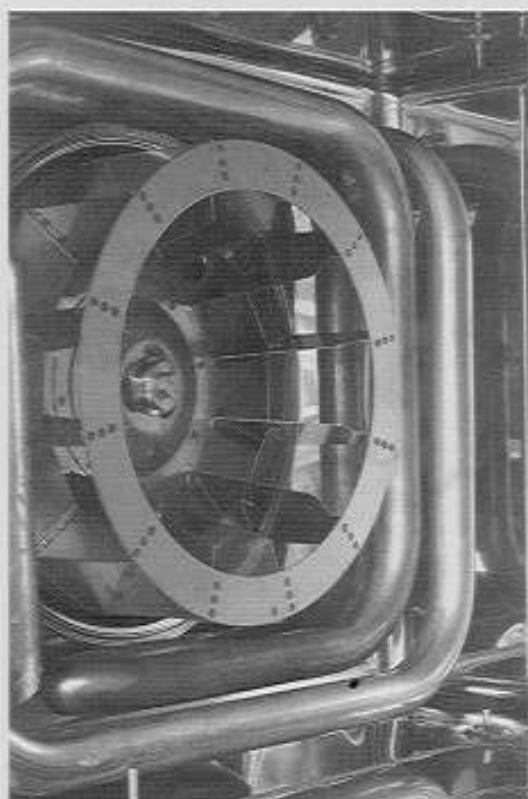

Pos.	St.	Ersatzteil Nr.	Bezeichnung	Description	Bez. Sign.
Pos.	Pcs.	Spare part no.			
1	1	3100.1024	Lüftermotor	Fan motor	M1
-	4	1108.0260	Sechskantmutter M 8	Hexagonal nut M8	
-	4	1208.0260	Federring B8	Spring washer B8	
2	1	5001.0207	Motorwellendichtung	Motor shaft gasket type	
3	1	2016.0876	Dichtungsflansch für Motorwelle	Gasket flange for engine shaft	
-	4	1106.0220	Sechskantmutter M6 flach	Hexagonal nut M6 flat	
-	4	1306.0120	Unterlegscheibe A6,4	Washer A6.4	
4	1	2012.0507	Lüfterrad	Fan wheel	
5	1	1010.0762	Sechskantschraube M 10x20	Hexagonal screw M10x20	
6	1	1328.0102	Sperrkantscheibe A10,2	Safety washer A10,2	
7	1	3001.0461	Kondensator 20µF	Capacitor 20µF	C1
8	1	3001.0458	Kondensator 30µF	Capacitor 30µF	C2
9	1	2724.1333	Halteplatte für Kondensator	Mounting bracket motor capacitor	

Wasseranschluß, Ablöschung / Water supply, Quenching box

Spannung / Voltage: **1 N AC 230V 50Hz**

Baugruppe / Group: **10** Ausgabe / Edition: **10.1.1**

Gültig ab Seriennummer / Applicable from serial. no.: **G61CA97101001**

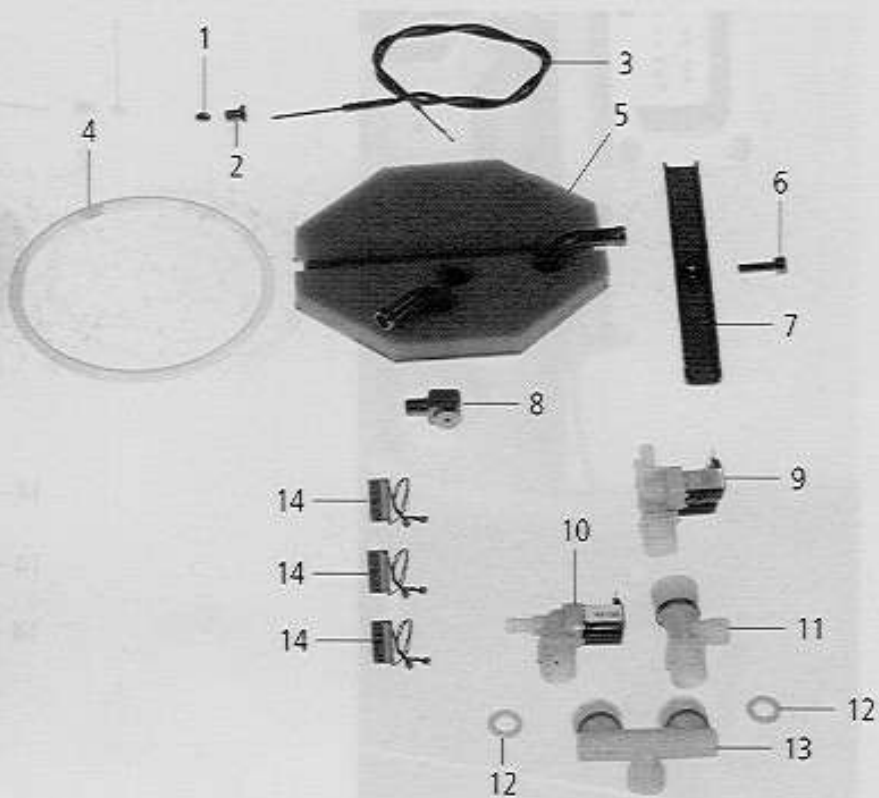
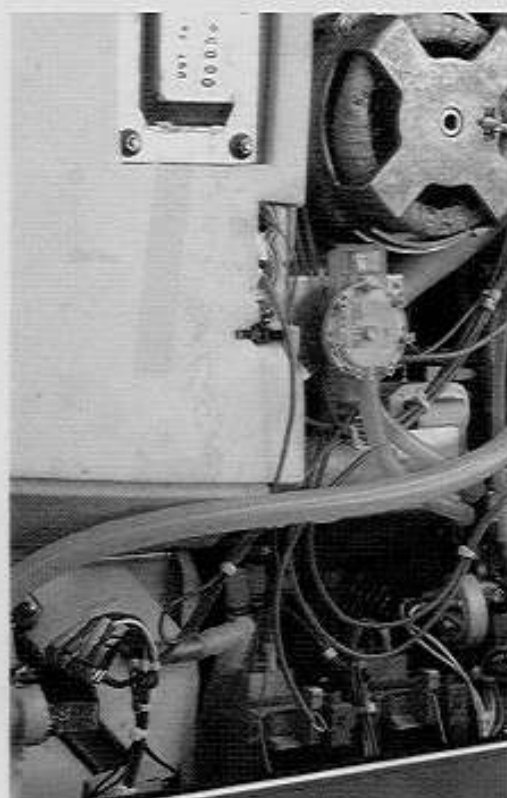

Pos.	St.	Ersatzteil Nr.	Bezeichnung	Description	Bez. Sign.
Pos.	Pcs.	Spare part no.			
-	-	2067.0050	Silikonschlauch 1m	Silicone hose 1m	
-	1	2062.0332	Rückschlagventil	Check valve	
-	6	2066.0205	Schlauchschelle 12-18mm	Hose clamp 12-18mm	
1	1	3014.0162	Dichtkegel für Thermoelement	Sealing cone for thermo element	
2	1	3014.0163	Stopfbuchsnippel für Thermoelement	Gasket sleeve with nipple	
3	1	3014.1005	Thermoelement kurz	Thermocouple short	B2
4	1	5012.0566	O-Ring Dichtung Ablöschkasten	O-Ring gasket quenching chamber	
5	1	8666.1318	Flansch Ablöschkasten	Flange quenching chamber	
6	1	1008.0752	Sechskantschraube M5x10	Hexagonal screw M5x10	
7	1	2715.1320	Spannbügel für Revisionsdeckel Ablöschkasten	Cross bar for cover quenching box	
8	1	2016.0935	Ablöschdüse 2,3 l/min	Quenching nozzle 2.3 l/min.	
9	1	3002.0330	Doppelmagnetventil kpl. 220-240V 50Hz	Double solenoid valve unit 220-240V 50Hz	Y1,Y3
10	1	3002.0331	Einfachmagnetventil kpl. 220-240V 50Hz	Single solenoid valve unit 220-240V 50Hz	Y2
11	1	8664.1300	T-Stück Wasseranschluss Handbrause	T-water connection handshower	
12	3	5110.1024	Dichtung für Verschraubung G 3/4"	Gasket for G3/4" threaded joint	
13	1	8664.1301	Brückenfitting 3/4" Wasseranschluss	Water connection fitting 3/4"	
14	3	3035.0508	RC-Glied	RC-link	C7-C9